



# Assembly Line Scrapbooking

## August 2009 Club Scrap® Apothecary

### Materials:

- Apothecary CS® Kit
- Apothecary Embellishment Pack
- Apothecary Wood Mounted Stamp
- Apothecary Unmounted Borders & Backgrounds

### Tools:

- 12" Paper Trimmer
- 13" CS® Grid Ruler
- Adhesive
- Foam Tape
- Glue Lines
- Tape
- Scissors
- Wine Ink
- Paper Piercing Tool
- Cork Board

### Fraction to Decimal Conversions

$1/8" = .125"$     $1/2" = .5"$     $7/8" = .875"$

$1/4" = .25"$     $5/8" = .625"$

$3/8" = .375"$     $3/4" = .75"$

*Note: We have incorporated items from the Embellishment Pack, Wood Mounted Stamp and Unmounted Borders and Backgrounds into many of this month's layouts. If you do not have all of these items, simply make a substitution or eliminate the step.*



The edges of many pages, photo mattes, and other elements have been edged with wine ink; however, instructions to do so are not included below.

**Layout #1 and #2**

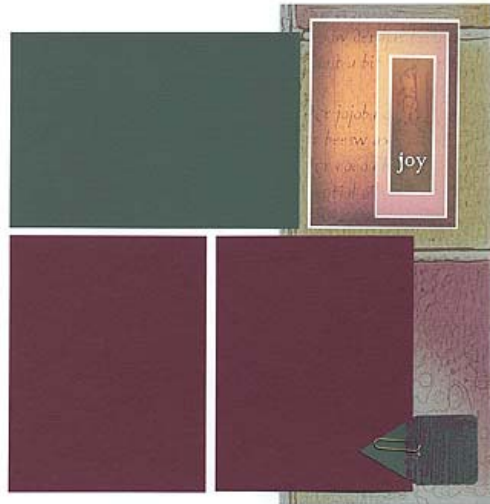
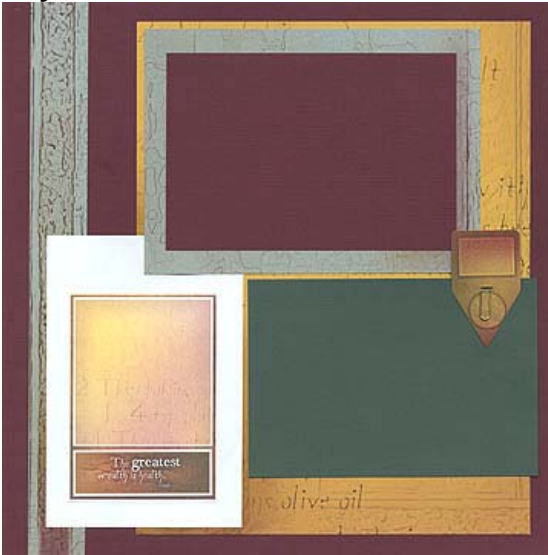

- 12x12 Wine Plain
- 12x12 White Cover Plain
- 12x12 Light Grey Print
- 8.5x11 Gold Print
- 8.5x11 Wine Plain
- (2) 4.25x6.25 Dark Grey Photo Mattes
- 4.25x6.25 White Text Photo Matte
- Gold Print and Dark Grey Plain Tags
- UM Borders & Backgrounds
- White Text Cutaparts
- (2) Gold Paper Clips

1. Place the 12x12 Light Grey Print into the trimmer with the border running vertically at right. Trim at 10.75". Cut the 10.75x12 horizontally at 7.25". Trim the 7.25x10.75 horizontally at 10.5 and 5.25".

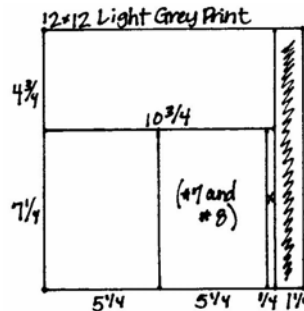

2. Cut the 8.5x11 Wine Plain vertically at 4.25". Trim one 4.25x11 horizontally at 5.5". Cut the other 4.25x11 horizontally at 6.25".

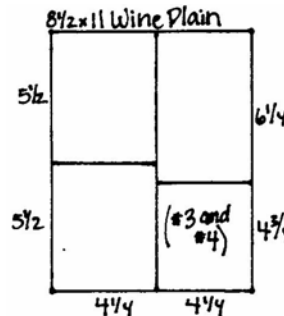

### Layout #3 and #4



- 12x12 Wine Print
- 12x12 Gold Plain
- 12x12 White Text Print
- (2) 4.25x6.25 Gold Photo Mattes
- 4.25x4.75 Wine Plain (From Layout #1 and #2)
- Good Health Sticker Cutaparts
- Light Grey Diecuts
- White Text Cutaparts
- (3) Gold Jewels

1. Place the 12x12 White Text Print into the trimmer with the bottle images vertically at left. Trim at 6 and 5.5". Cut the 5.5x12 horizontally at 7.5". Trim the 6x12 horizontally at 8 and 4".

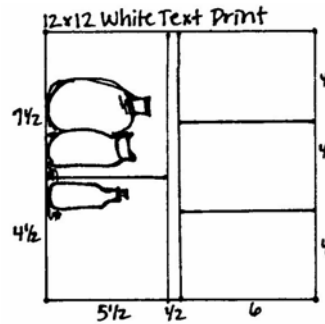

Layout #5 and #6

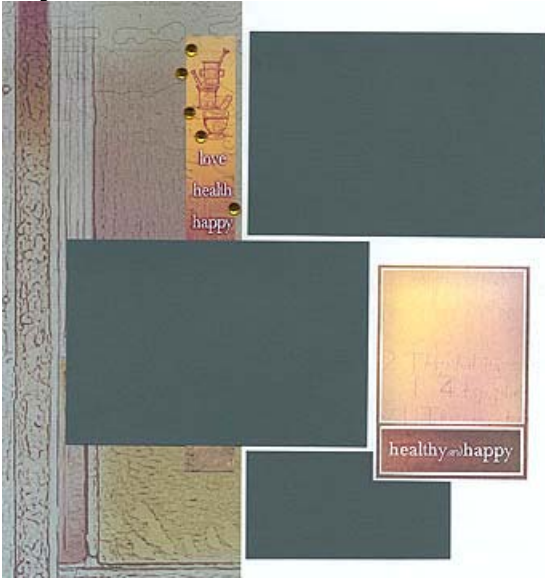

- 12x12 Light Grey Print
- 12x12 Dark Grey Plain
- 12x12 White Text Plain
- 8.5x11 Light Grey Print
- 8.5x11 Dark Grey Plain
- (2) 4.25x6.25 White Text Photo Mattes

- White Text Cutparts
- Good Health Sticker Cutaparts
- Gold Printed Tag
- (6) Gold Jewels
- Gold Paperclip

1. Trim the 12x12 White Text Plain at 7".

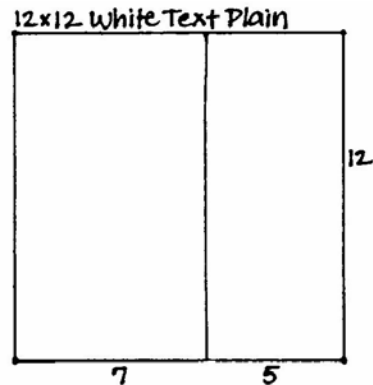

2. Cut the 8.5x11 Dark Grey Plain horizontally at 10.5 and 6.25". Trim the 6.25x8.5 horizontally at 4.25". Cut the 4.25x8.5 horizontally at 6.25".

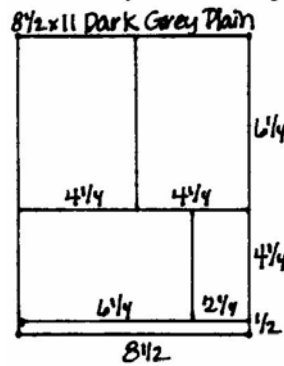

Layout #7 and #8

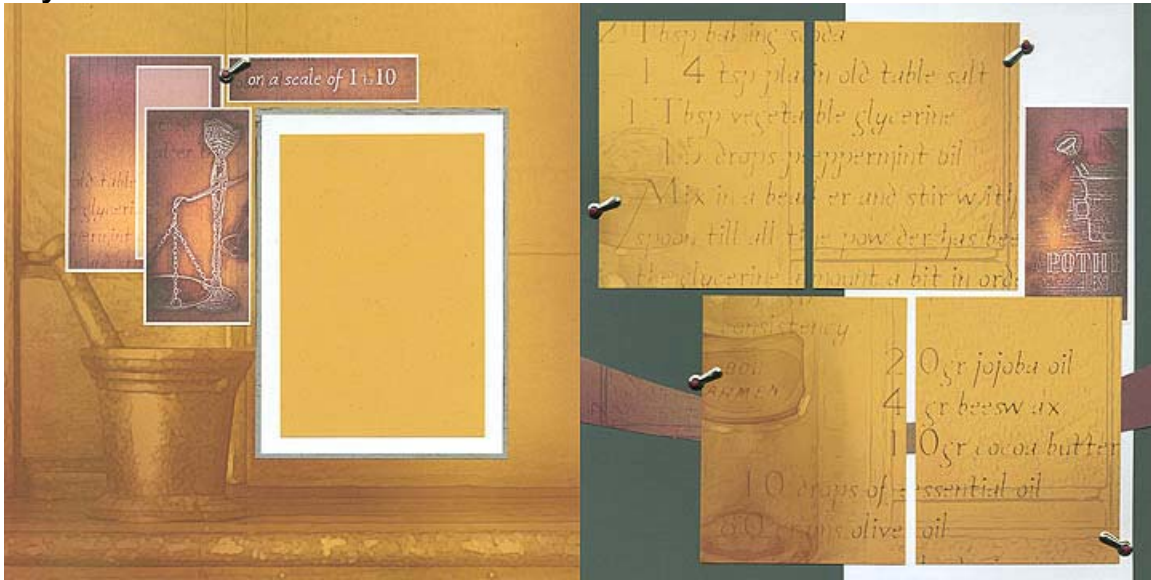

- 12x12 Gold Print
- 12x12 Dark Grey Plain
- 12x12 White Text Plain
- 8.5x11 Gold Print
- 5.25x7.25 Light Grey Print (From Layout #1 and #2)
- 4.25x6.25 Gold Photo Matte
- White Text Cutaparts
- Light Grey Die Cuts
- (5) Silver Photo Turns
- (5) Wine Brads

1. Trim the 12x12 White Text Plain at 11.5, 11, and 6". Cut the 5x12 horizontally at 7".

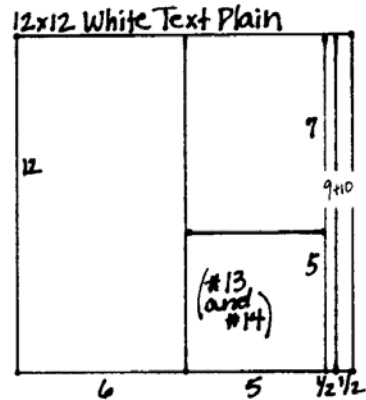

2. Cut the 8.5x11 Gold Print vertically at 4.25". Trim each 4.25x11 horizontally at 5.5".

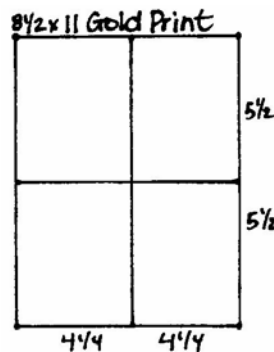

Layout #9 and #10



- 12x12 White Cover Plain
- 12x12 Wine Plain
- 8.5x11 Light Grey Print
- 8.5x11 Dark Grey Plain
- 8.5x11 White Text Plain
- (3) 4.25x6.25 Wine Photo Mattes
- 4.25x6.25 Dark Grey Photo Matte

- (2) .5x12 White Text Plain (From Layout #7 and #8)
- UM Borders & Backgrounds
- Good Health Sticker Cutaparts
- White Text Cutaparts
- Gold Printed Tags
- (2) Gold Paperclips

1. Trim the 8.5x11 White Text Plain vertically at 6". Cut the 6x11 horizontally at 8 and 4". Trim the 3x6 horizontally at 5.25". Cut the 2.5x11 horizontally at 10, 7.5, 5, and 2.5".

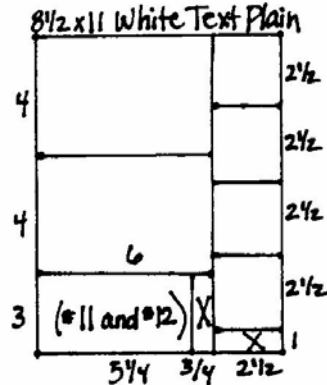

Layout #11 and #12



- 12x12 Gold Print
- (2)12x12 Light Grey Plain
- 12x12 White Text Print
- 3x5.25 White Text Plain (From Layout #9 and #10)

- Light Grey Die Cuts
- Wine Grosgrain Ribbon
- Good Health Sticker Cutaparts
- Wood Mounted Stamp

1. Place the 12x12 White Text Print into the trimmer with the bottles images vertically at left. Trim at 6". Cut the 6x12 non-image side horizontally at 8 and 4".

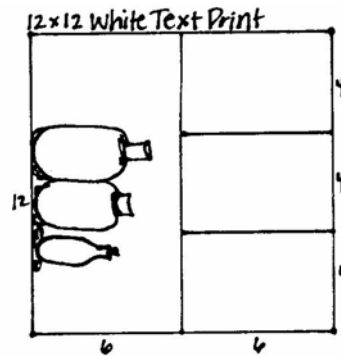

2. Cut one 12x12 Light Grey Plain at 6". Trim one 6x12 horizontally at 8 and 4".

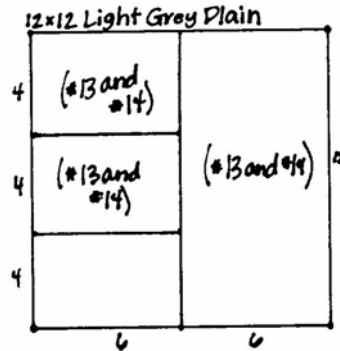

Layout #13 and #14

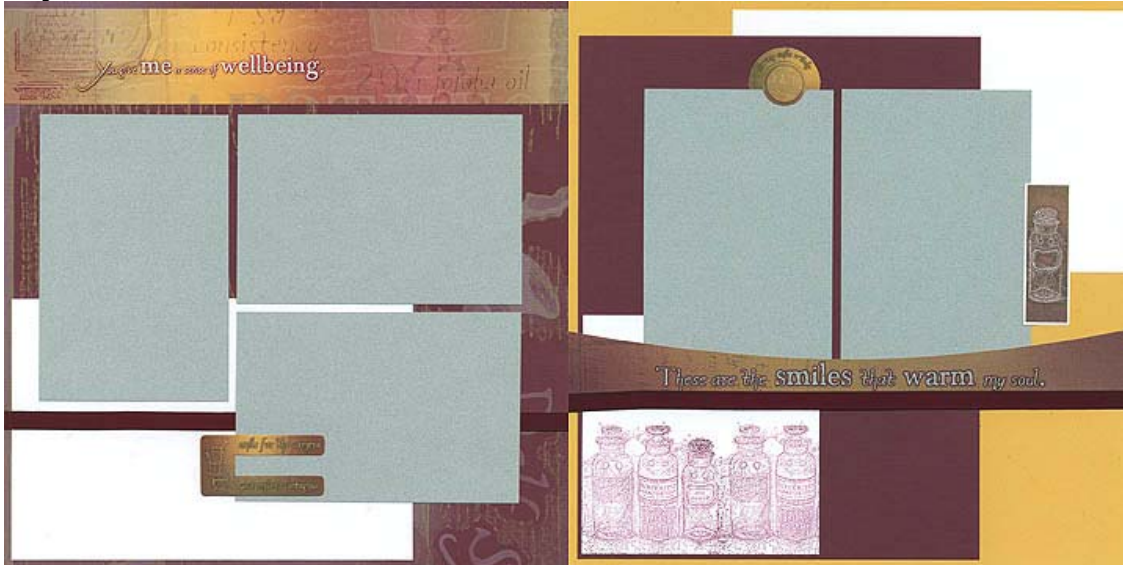

- 12x12 Wine Print
- 12x12 Gold Plain
- 8.5x11 Wine Plain
- 8.5x11 White Text Plain
- (2) 4x6 Light Grey Plain (From Layout #11 and #12)
- 6x12 Light Grey Plain (From Layout #11 and #12)
- 5x5 White Text Plain (From Layout #7 and #8)
- UM Borders & Backgrounds
- Good Health Sticker Cutaparts
- Wine Grosgrain Ribbon
- White Text Cutaparts
- Light Grey Die Cuts
- Gold Print Tags

1. Trim the 8.5x11 White Text Plain horizontally in half at 5.5”.

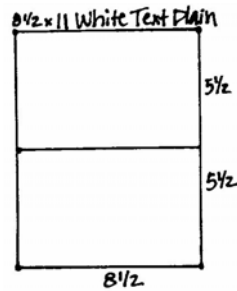

2. Cut the 6x12 Light Grey Plain horizontally at 8 and 4”.

