

Assembly Line Scrapbooking

January 2009 Club Scrap® JR Gimme a Ring

Materials:

- Gimme a Ring CS® JR Kit

Tools:

- 12" Paper Trimmer
- 3x13" CS® Grid Ruler
- Adhesive
- Scissors

Fraction to Decimal Conversions

$1/8" = .125"$ $1/2" = .5"$ $7/8" = .875"$

$1/4" = .25"$ $5/8" = .625"$

$3/8" = .375"$ $3/4" = .75"$



The edges of many pages, photo mattes, and other elements have been edged with “Night Sky” ink included in your kit; however, instructions to do so are not included below.

Layout #1 and #2

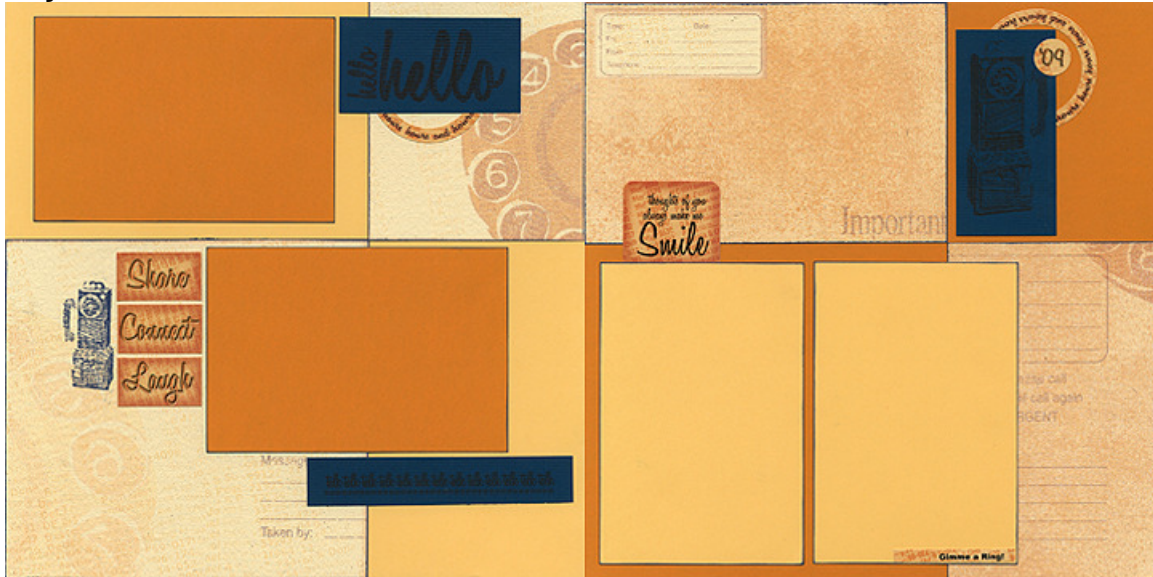

- 12x12 Bisque Cover Print
- 12x12 Light Maize Plain
- 12x12 Dark Maize Plain
- (2) 4.25x6.25 Light Maize Photo Mattes
- (2) 4.25x6.25 Dark Maize Photo Mattes
- Wood Mounted Stamp
- Night Sky Ink
- Navy Cutaparts
- Stickers

1. Trim the 12x12 Bisque Cover Print, along it's natural lines, at 7.5". Rotate the 4.5x12 and 7.5x12 horizontally; cut at 7".

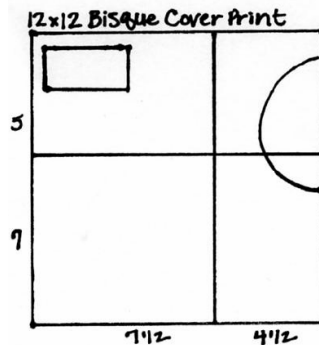

Layout #3 and #4

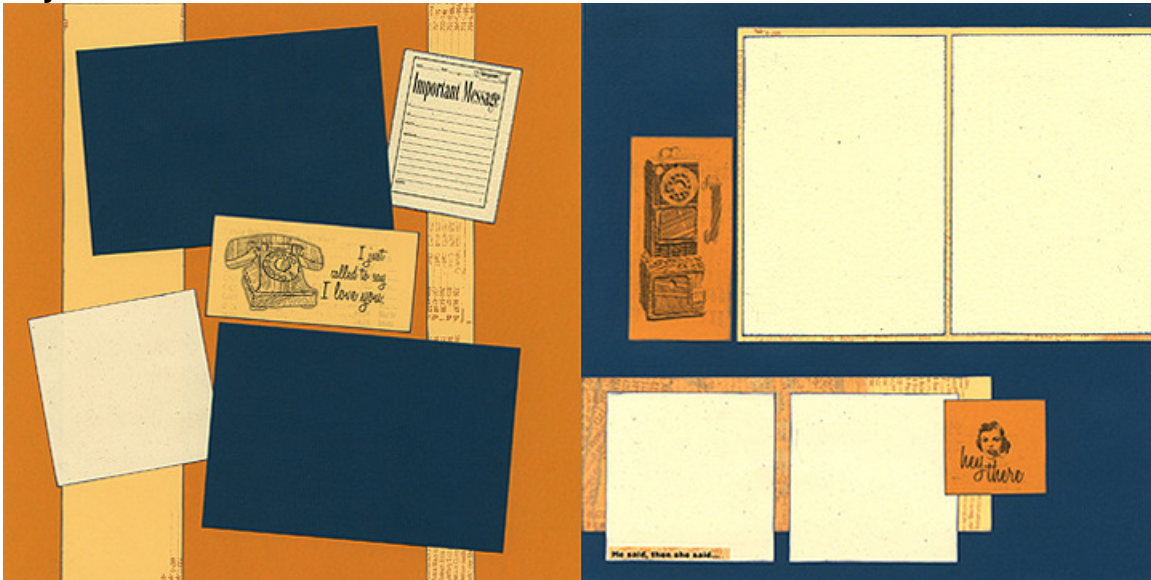

- 12x12 Light Maize Print
- 12x12 Dark Maize Plain
- 12x12 Bisque Cover Plain
- 12x12 Navy Plain
- (2) 4.25x6.25 Navy Photo Mattes
- (2) 4.25x6.25 Bisque Cover Mattes
- Bisque Cover, Light and Dark Maize Cutaparts
- Stickers

1. Trim the 12x12 Light Maize Print at 11 and 8.5". Cut the 8.5x12 piece horizontally at 8.75". Cut the 8.5x8.75 horizontally at 6.5".

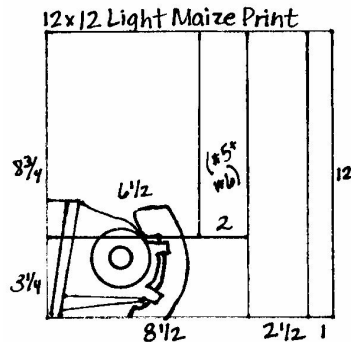

2. Cut the 12x12 Bisque Cover Plain at 8.5". Trim the 3.5x12 horizontally at 10.5, 7, and 3.5".

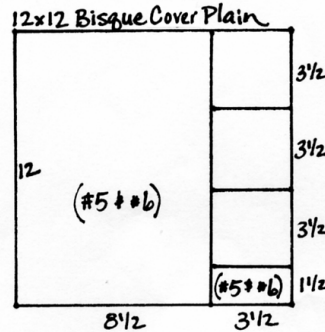

Layout #5 and #6

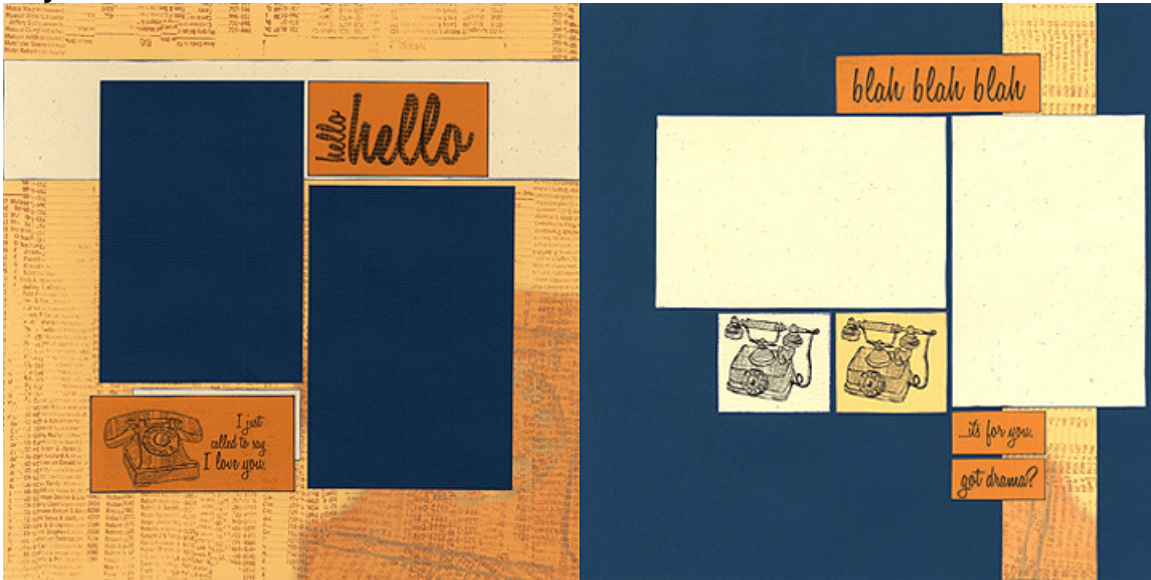

- 12x12 Light Maize Print
- 12x12 Navy Plain
- 8.5x12 Bisque Cover Plain (From #3 and #4)
- 2x8.75 Light Maize Print (From #3 and #4)
- 1.5x3.5 Bisque Cover Plain (From #3 and #4)
- (2) 4.25x6.25 Navy Photo Mattes
- Light and Dark Maize, Bisque Cutaparts

1. Trim the 8.5x12 Bisque Cover Plain vertically at 6". Cut the 6x12 horizontally at 8 and 4".

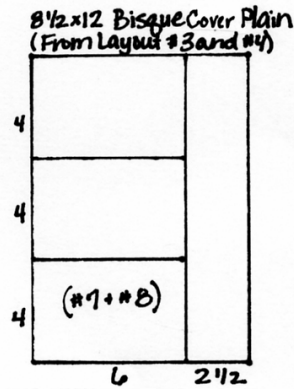

2. Cut the 2x8.75 Light Maize Print horizontally at 4.75".

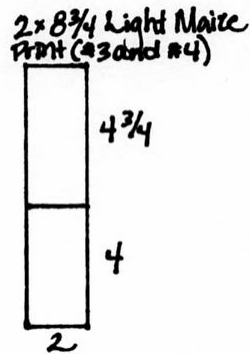

Layout #7 and #8

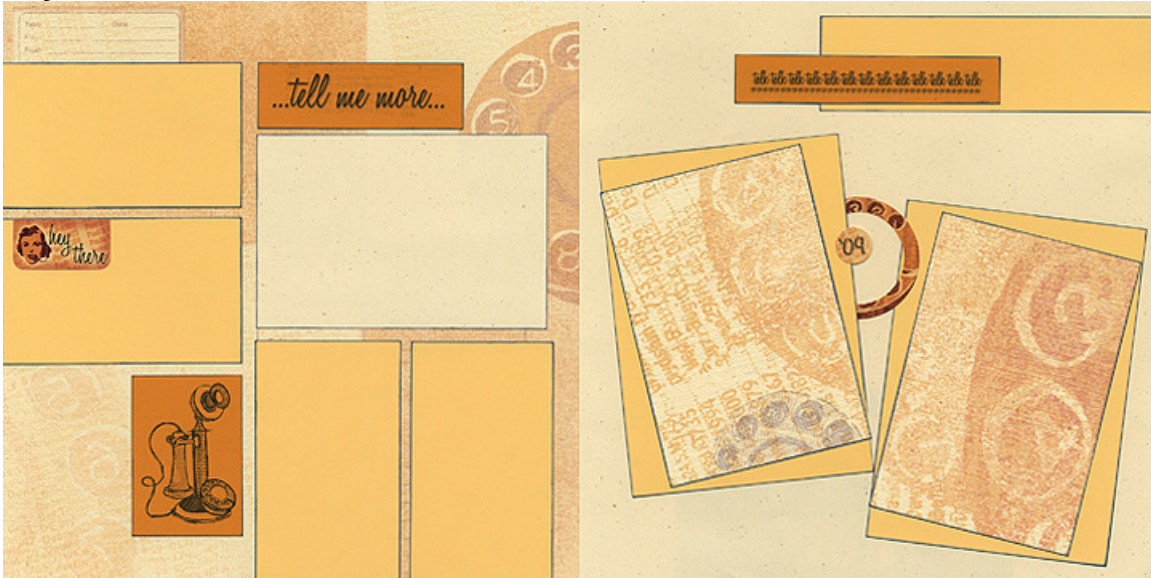

- 12x12 Bisque Cover Print
- 12x12 Bisque Cover Plain
- 12x12 Light Maize Plain
- 4x6 Bisque Text Plain (From Layout #5 and #6)
- (2) 4.25x6.25 Bisque Text Print Photo Mattes
- Dark Maize Cutaparts
- Stickers

1. Trim the 12x12 Light Maize Plain at 7". Cut the 7x12 horizontally at 10 and 5". Trim the 5x12 horizontally at 9, 6, and 3".

